

**SEEPEX.**  
An Ingersoll Rand Business

# FOR VISCOUS PRODUCTS PRODUCT GROUP T

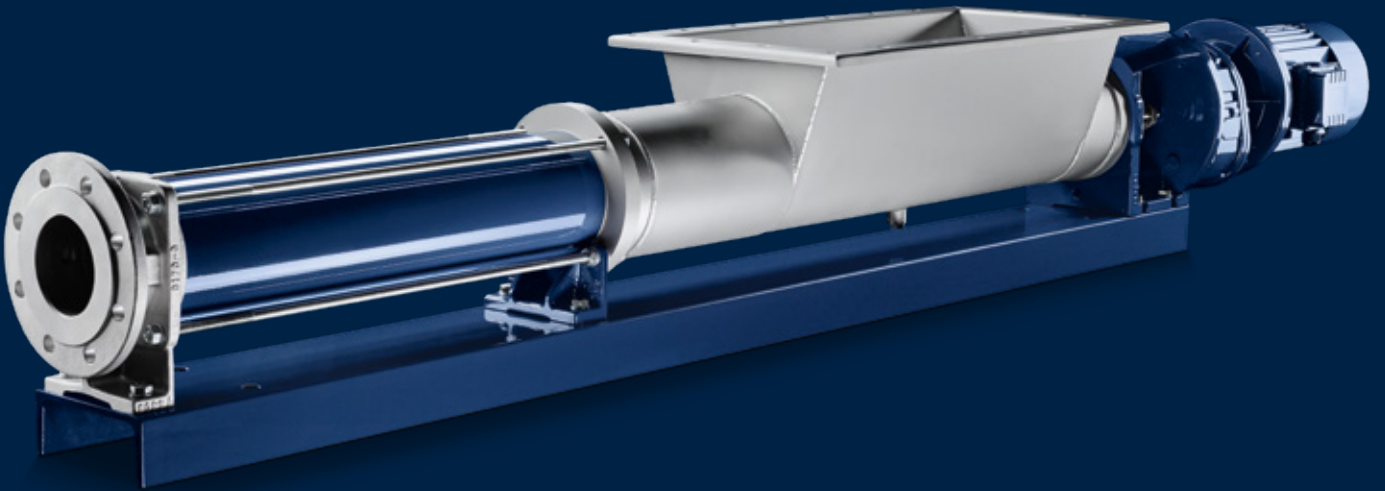

# FOR HIGH SOLIDS CONTENT.

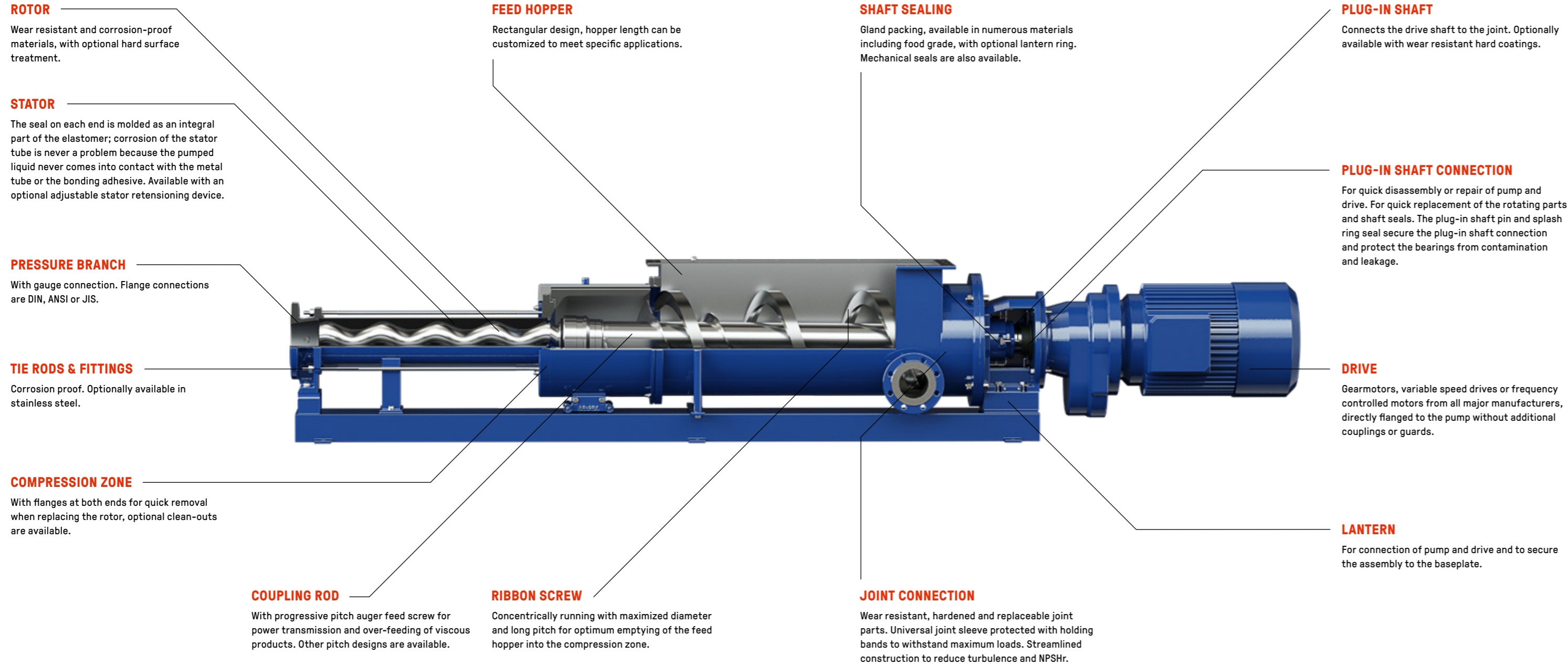

Picture: BTHE range pump

SEEPEX open hopper pumps handle viscous products with or without entrained solids that have little or no flowability. They come in ten ranges with multiple variations within each range and are suitable for nearly all industries.

## OVERVIEW OF RANGES

### BTQ RANGE

BTQ range pumps are identical in length to the pumps of the BN range and feature a square inlet and an auger feed screw for enhanced product feed. They are used for pumping medium to highly viscous products with some degree of flowability.

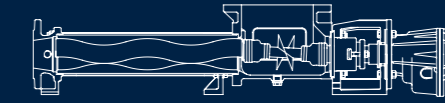

### BT RANGE

BT range pumps feature a rectangular feed hopper with compression zone and auger feed screw. They are used for pumping highly viscous media with a low degree of flowability.

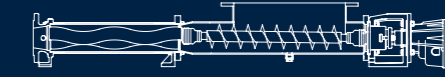

### BTM RANGE

A special characteristic of the BTM range is the chopping system integrated into the compression zone. The knives on the rotating auger in combination with the cutters fastened to the compression housing chop up a variety of solids. Integrated into a closed system, the pump permits maceration with direct conveying in the following pipe work.



### BTVE RANGE

BTVE range pumps feature a sliding compression casing with an enlarged cross section to simplify service. A solid auger feed screw with a long pitch, enlarged diameter and increased blade thickness for durability enables longer operating times.

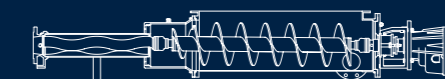

### BTI RANGE

BTI range pumps feature a rectangular feed hopper with an integrated bridge breaker. The compression housing is removable for service work. Pumps of this range are used for pumping highly viscous products that bridge above the auger feed screw. They can also be used to mix granular products like quicklime used for Class "A" biosolids.

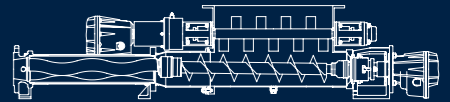

### BTHE RANGE

BTHE range pumps feature a feed hopper with vertical hopper walls and a ribbon screw rotating concentrically. This guarantees optimum emptying of the feed hopper and optimized feed of the product into the conveying elements of the pump.



### BTH RANGE

The BTH range combines various advantages of product group T. It is characterized by a separately driven, concentrically rotating ribbon screw with a maximized diameter and a long pitch length. Through separate control of the conveying screw speed, the BTH pump can be used for almost any conveying media. The variable speed auger screw permits optimum filling of the rotor and stator without causing build-up in the compression zone. Even media that tends to bridge can be handled with ease due to the large screw diameter of the BTH pump. The BTH range is the technical optimum solution for shear-thinning products.



### BTES RANGE

The BTES range is equipped with a closure mechanism that seals the pump inlet from the rotor and stator, making their replacement easy and cleaner even with the silo filled.

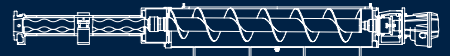

## OVERVIEW OF RANGES

### BTEI RANGE

The BTEI range pumps are equipped with a bridge breaker/mixing device. The optional enclosed buffer tank, which can be adapted to the application conditions on site, replaces a separate storage tank, saving space within the system. Numerous process monitoring devices, like level sensors, can be mounted.

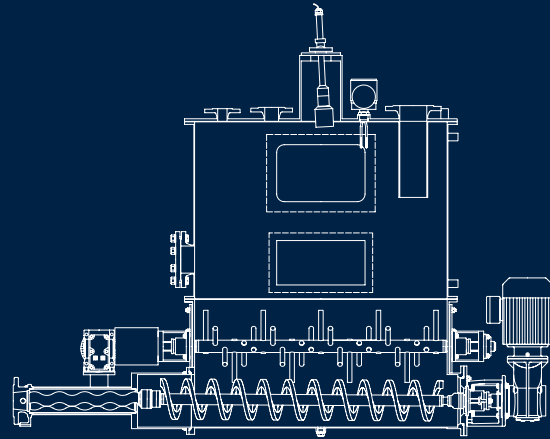

### BTEX RANGE

The BTEX range with its robust design and reinforced components is used in extreme applications in the agriculture and biogas industries. In these applications, the conveyed products can contain solids like stones, pieces of wood or metal parts. During the pumping process, debris is separated from the media in the hopper/compression housing unit and can be easily removed via the large inspection openings. A significant feature is the removable compression housing, which greatly simplifies maintenance. Depending on the application, the connections in the hopper/compression housing can be used for feeding the liquid during mixing.



## APPLICATIONS

SEEPEX open hopper pumps have a feed hopper and an auger feed screw to positively feed products into the pumping elements. The pitch and diameter of the auger can be adjusted according to operating conditions for optimal product feed. The feed hopper can be designed to suit diverse application conditions. They are suitable for many applications in agriculture, biogas, brewing and distilling, ceramics, confectioneries, construction, doughs and creme fillings, dyes, paint and varnish, electroplating, fish processing, fruits, vegetables, pharmaceuticals, cosmetics, poultry and meat processing, oil, natural gas liquids, petrochemicals, shipbuilding, sludge dewatering and treatment, wastewater treatment, paper stock, textiles, wood treatment, glues, adhesives, mastics and wineries.

### FEATURES

- Open hopper and auger feed screw design
- Optimum product handling: open hopper and auger feed screw are customizable for each application
- Easy maintenance due to quick access to the joints, removable compression zone, the BTES closure mechanism and the plug-in shaft connection
- BTM range pumps incorporate cutting knives for chopping and/or crushing of the pumped product
- Robust design for demanding applications
- Liquid addition points in the hopper and compression zone

### KEY FACTS

- Conveying capacity:  
50 l/h–500 m<sup>3</sup>/h (0.220–2,200 USGPM)
- Pressure:  
36 bar (525 psi), select sizes also in 48 bar (700 psi)

SEEPEX GmbH

[www.seepex.com](http://www.seepex.com)